

THIS DRAWING IS FOR
PLANNING PURPOSES ONLY
DO NOT USE FOR
CONSTRUCTION

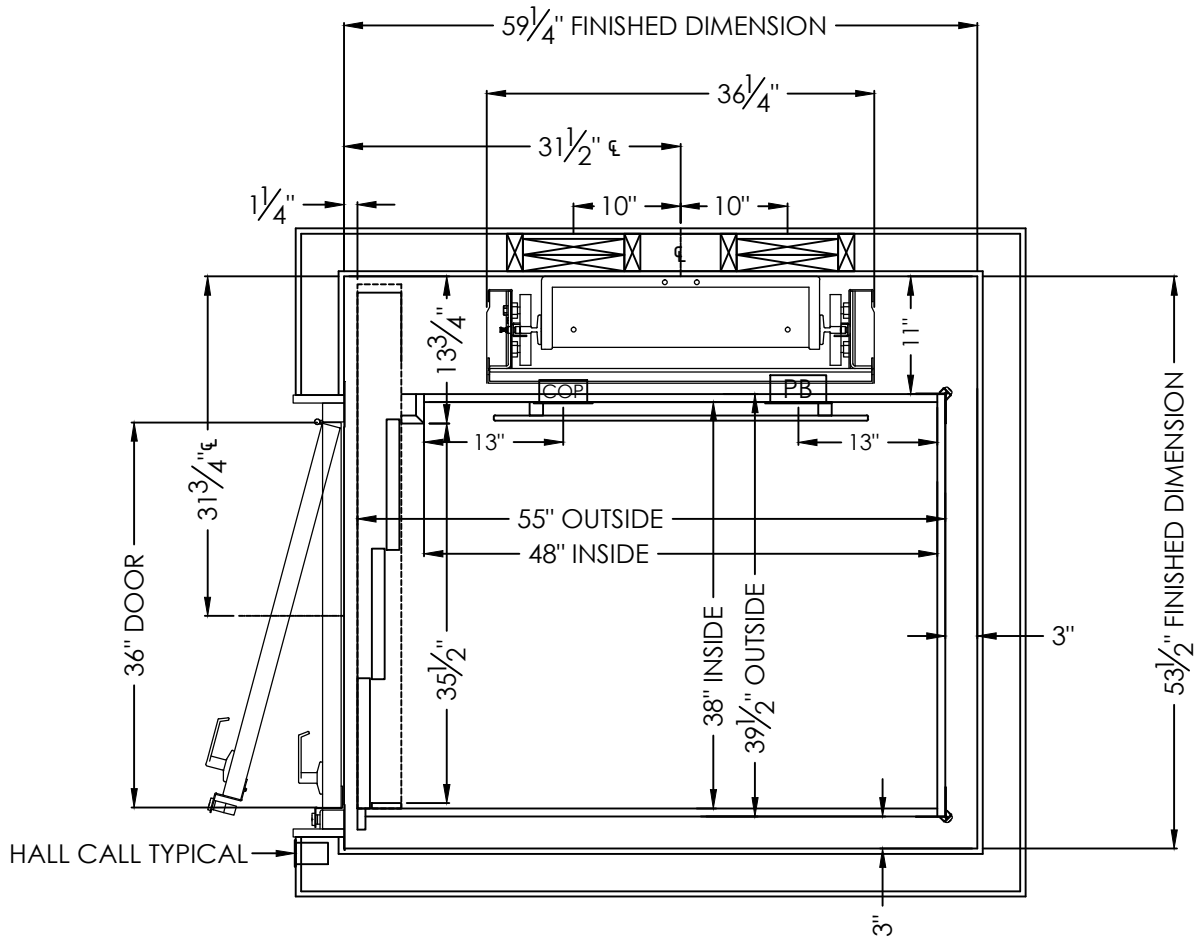

NOTES:

CAR FLOORING AND FINISHINGS MUST NOT EXCEED 25 LBS

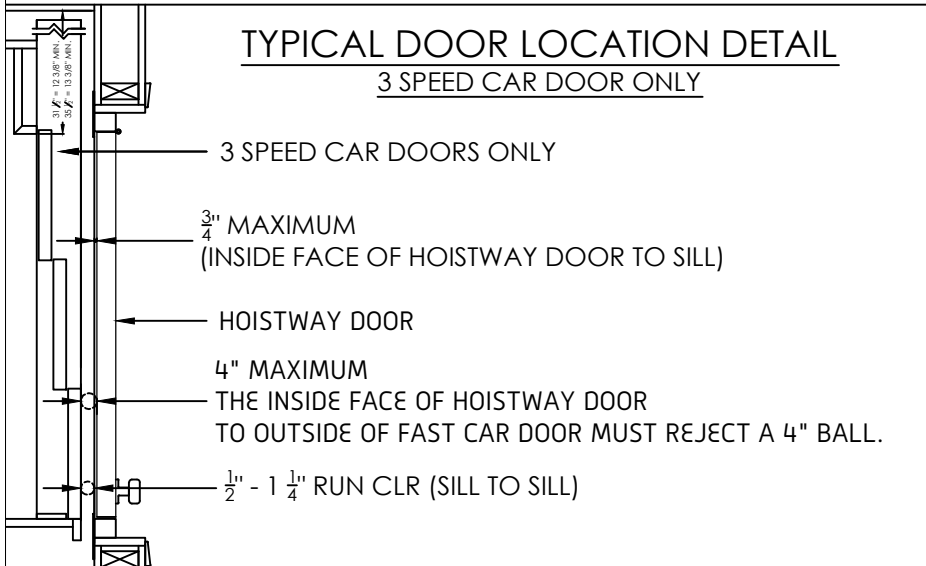

		SYMMETRY ELEVATING SOLUTIONS PH 877-375-1428	
		TITLE 38 X 48 SINGLE OPENING RL RH	
DRAWN BY	ORIGINAL DATE 04-02-2020	DRAWING NO. RE110	SCALE NONE REV 0
JOB INFORMATION THIS DRAWING IS FOR PLANNING PURPOSES ONLY, DO NOT USE FOR CONSTRUCTION			